



Nova Pro Mobile Tablet Station

ASSEMBLY KIT

Nova Pro Hardware Packs

Nova Pro Pole Assembly Hardware Pack

- 1 of 3/32 Hex Key
- 1 of 5/16"-18 x 1 1/4" flange bolt
- 1 of 10-32 x 7/8" set screw

Nova Pro Bracket Assembly Hardware Pack

- 1 of 1/4"-20 x 7/16" Toplock nut
- 2 of 10-32 x 3/8" Long flat-head socket cap screws
- 1 of 1/8" Hex Drive Key
- 1 thick swivel head washer
- 1 thin swivel head washer
- 1 Set of 2 keys

Nova Pro Wire Basket Hardware Pack

- 2 of 10-32 x 3/8" long flat-head socket cap screws
- 1 - 1/4 turn 1/4"-20 Z-Nut
- 1 screw for 80/20 nut, socket head cap screw 1/4"-20 x 1.5" long

ADDITIONAL TOOLS REQUIRED

- 7/16" Socket, 1/2" Socket

ASSEMBLY INSTRUCTIONS

1. OPEN THE SHIPPING BOX

- Open shipping box and remove base assembly.

BASE ASSEMBLY



- Extract hardware pack.

HARDWARE PACK



- Remove Pole assembly from packaging.

POLE ASSEMBLY



2. ASSEMBLE THE POLE ASSEMBLY

- Assemble the Pole assembly to the base with the 4 screws and dome washers using the 3/16-inch hex L key from the hardware pack.

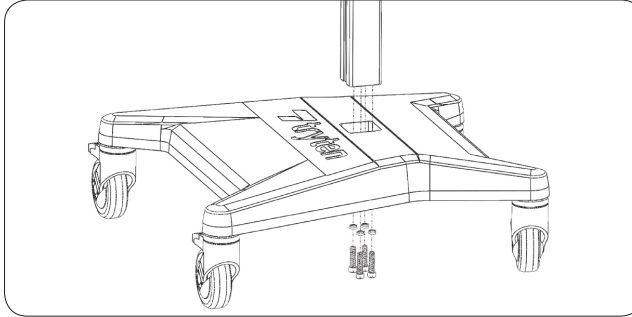

3A. ADJUST OMNITAB UNIVERSAL BRACKET TO FIT TABLET

The Universal bracket comes adjusted to fit the standard iPad 9.7.

- Unlock the top slider using the set of keys from the hardware pack.
- Remove the top slider from the OmniTab.
- Loosen the 3 screws using the 1/8-inch hex L key from the hardware pack.

ADJUSTMENT SCREWS

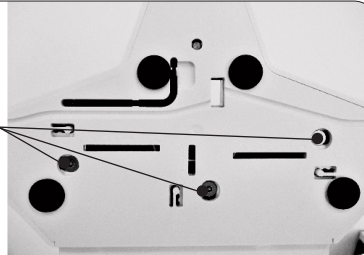

- Pull sliders to the appropriate size tablet.
- Tighten the three adjustment screws.
- Slide the tablet into place.
- Insert the Top slider and push the locking button.

LOCK BUTTON

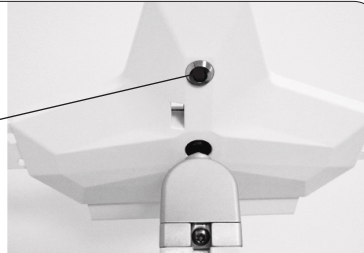

3B. WHEN A TABLET HAS A CASE, INSTALL 2ND SET OF SLIDERS

- a) Remove 4 felt pads from Universal bracket.

FELT PADS

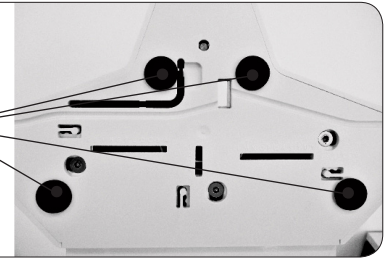

- b) Remove 4 screws holding the cover of the Universal bracket using the 1/8-inch hex L key from the hardware pack.

COVER HOLDING SCREWS

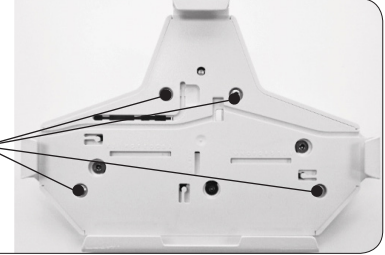

- c) Remove cover and the 3 screws holding the sliders using the 1/8-inch hex L key from the hardware pack.

- d) Remove for sliders and replace with the set of sliders from hardware pack.
- e) Install the 3 screws holding the sliders using the 1/8-inch hex L key from the hardware pack.

SLIDERS HOLDING SCREWS

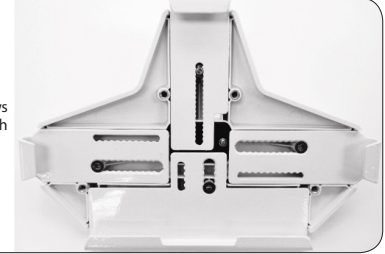

- f) Put back the cover and install the 4 screws removed at step b) using the 1/8-inch hex L key from the hardware pack.

COVER HOLDING SCREWS

- g) Apply the set of felt pads supplied in the hardware pack on top of the screws.

- h) Adjust sliders and install tablet following the instructions from Step 4.

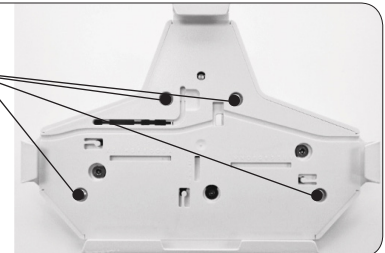
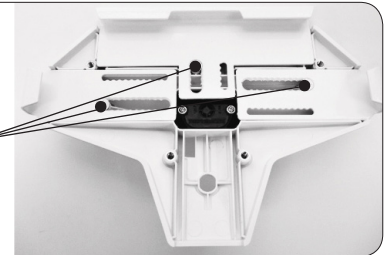



Nova Pro Mobile Tablet Station

ASSEMBLY INSTRUCTIONS - *continued*

4. REMOVE CHANNEL COVER STRIPS

Insert one of the smaller Allen keys in behind the top of the channel cover to pull out of the pole. You need to reinstall these covers back into place after power cords are in place.

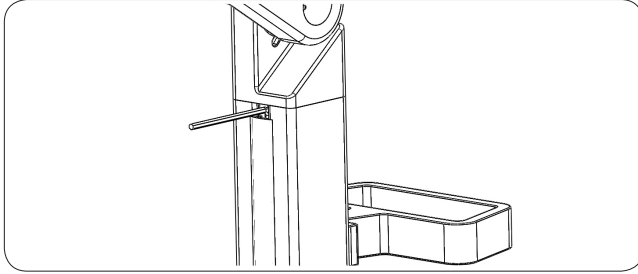

NOTE: Channel cover strips will need to be adjusted if you purchase accessories.

5. INSTALL THE POWER CORD

- To install the power cord, charging cable and power adapter, you first must open the Power Box, located in the center of the pole. Turn the unit around to the back to locate 2 screws at the back of the Power Box. Using your 3/32 Allen Key, loosen and remove the 2 screws located on the back of the Power Box. Keep screws in a safe place.
- The Power Box cover should now easily slide off by lifting it up or down.
- Turn the unit back around so the front of Power Box is facing you.
- Slide the small end of the Apple Lightning Connector cable into the small hole of the Power Box, and up the pole. It should easily fit. Leave the other end of the Lightning cable inside the power box to connect later.
- Plug your tablet's power adapter (inside the Power Box) into the 9' Green Dot Certified Hospital Grade power extension cable.
- The power extension cable can now fit inside the bottom slot of the Power Box to store cables firmly inside the Power Box.
- Slide Power Box cover back into place and screw the Power Box back into place using the 2 screws and the 3/32 Allen Key. Make sure both screws are lined up properly before tightening completely.
- Reinstall top 2 channel covers to protect your charging cable that runs up inside the pole. Leave room at the top for the cable to poke through in both channel covers. Make sure that the cable has enough flexibility for the unit to bend. Do not thread cable too tightly inside the unit. There should be ample cable slack along the pole.
- Connect your tablet's charging cable to your tablet.

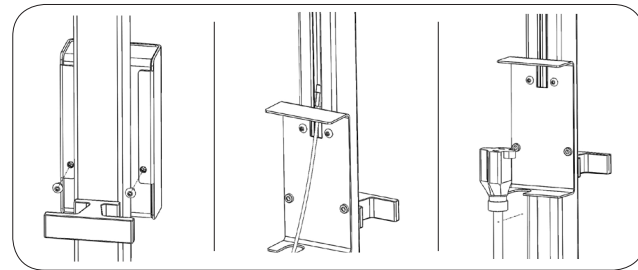

STORING THE POWER CORD

When the cart is not in use, or tablet is not being charged, the extension cord should be wrapped and stored on the unit. Wrap the cable firmly around the upper handle and lower handle cord wraps located on the back of the unit pole.

6. INSTALL THE WORK SURFACE ACCESSORY TRAY

- Remove the channel cover strip. Channel cover will need to be resized after installation of tray.
- The tray comes with 2 screws and 2 Z-nuts.
- Loosen Z-nuts from screws but do not remove; align Z-nuts so they slide into pole channel.
- Use 5/32" allen key to tighten screws. Before tightening completely, adjust height of tray to desired position and then tighten screws.
- The channel strip can be resized to suit the Work Surface location.

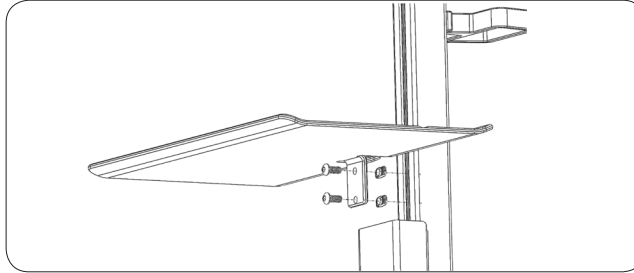

7. INSTALL THE WIRE STORAGE BASKET ACCESSORY

The wire basket storage accessory comes in 3 parts – the basket itself, the mounting bracket and clamp to attach to the pole. The storage basket gets installed just below the power box on the lower part of the pole.

- First, remove the lower channel cover. Use an Allen key at the base of the channel cover to pry it off of the pole.
- In the basket hardware kit you will find a 1/4" screw and a T-nut. Insert screw into basket bracket and thread on the T-nut but do not tighten. Make sure the T-nut is in the proper orientation so it fits snugly inside the channel of the pole.
- Adjust height of mounting bracket now to where you want it.
- Tighten the mounting bracket into the pole when happy with the placement using the 3/16 Allen key.
- Place the top rim of the basket on the top of the mounting bracket.
- Center the basket to the middle of the pole.
- Attach the basket using the clamp which fits over the basket on top of the mounting bracket. The clamp is designed to fit over the basket grooves and attaches to the mounting bracket, holding the basket firmly in place.
- Install and tighten the 2 screws provided with your hardware kit using the 1/8 Allen key.
- Once you have the basket permanently in place, you can resize the lower channel cover strip. Measure the height of the remaining channel to size cover, leaving at least 1/4" of space at the top for the Lightning cable. You might need to cut two strips, depending on where you placed the storage basket. One strip above the storage basket and one strip below. Cut each strip to size and push back into place under and over the basket accessory.

